

IRPLDIM5E

4 Level Switch Dim Fluorescent Ballast using the IRS2530D *DIM8*TM

Table of Contents

	Page
1. Features	2
2. Overview	2
3. Circuit Schematics	3
4. Functional Description.....	4
5. Fault Conditions	10
6. Bill of Materials	14
7. IRPLDIM5E PCB Layout	15
8. Inductor Specifications	17

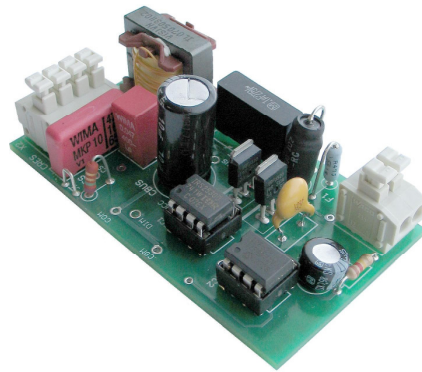

1. Features

- Drives 25W CFL Lamp
- Input Voltage: 220VAC
- High Frequency Operation
- Lamp Filament Preheating
- Lamp Fault Protection with Auto-Restart
- Low AC Line/Brownout Protection
- Microcontroller driven 4 level power pulse dimming
- IRS2530D *DIM8™* HVIC Ballast Controller

2. Overview

The IRPLDIM5E reference design kit consists of a dimming fluorescent ballast, with a microcontroller driven dimming control system providing four fixed levels and actuated by power re-cycle pulses of less than one second, driving a single 25W CFL lamp. The design contains an EMI filter and a dimming ballast control circuit using the [IRS2530D](#). This demo board is intended to help with the evaluation of the IRS2530D (*DIM8™*) dimming ballast control IC, demonstrate PCB layout techniques and serve as an aid in the development of production ballasts using the IRS2530D.

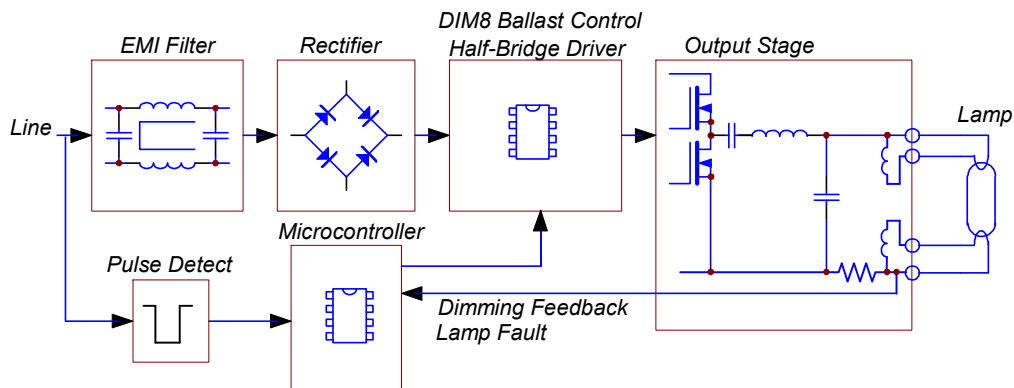

Figure 2.1: IRPLDIM5E Block Diagram

3. Circuit Schematic

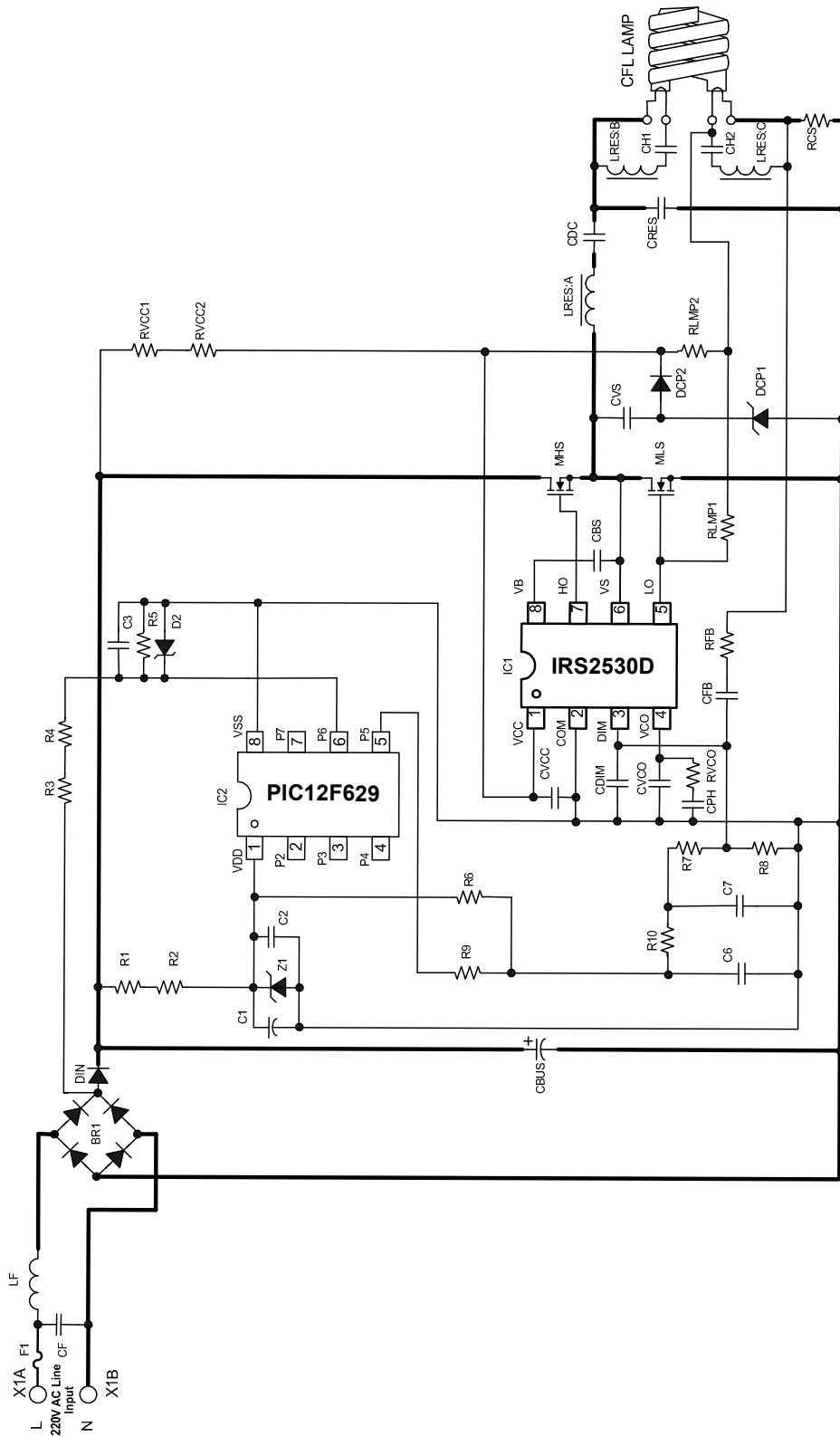

Figure 3.1: IRPLDIM5E Circuit Schematic

4. Functional Description

The IRPLDIM5E reference design is built on the IRS2530D (*DIM8™*) dimming platform. The lamp arc current is detected through RCS after ignition and added to a DC control voltage to provide an AC signal with a positive offset at the DIM pin of IC1. During DIM mode the IRS2530D adjusts the oscillator frequency in order to maintain the amplitude of this feedback signal such that the negative going peak is regulated at the 0V reference. In this way the peak to peak AC feedback signal amplitude is regulated to twice the DC control voltage level.

The IRS2530D incorporates a voltage controlled oscillator, whereby the voltage at the VCO pin determines the frequency. This is also used to realize the preheat and ignition ramp required to start the lamp. At switch on the voltage at the VCO pin will steadily rise from 0V. At 0V the frequency will be at its maximum level, which is considerably above the open circuit resonant point. As the voltage increases, the frequency gradually falls and the voltage at the lamp increases as well as the current in the cathodes. This configuration utilizes *voltage mode heating*, which is provided by means of two auxiliary windings on the resonant output inductor of the ballast circuit. This method is the simplest and cheapest, however *current mode heating* could be used if an additional transformer were to be added to sense the arc current.

As the frequency continues to fall, the voltage at the ballast output to the lamp increases until it reaches a point where it is sufficient to ignite the lamp. At this point arc current begins to flow in the lamp and a feedback signal is produced at the current sense resistor RCS. If ignition fails then the IRS2530D will shut down, going into a low VCC current fault mode.

The dimming control reference voltage is provided at the DIM pin of IC1 and generated by the micro controller IC2 at output GP2. GP pins refer to *general purpose I/O* pins of the micro controller, which can be configured by software as high impedance inputs or CMOS outputs. The DC dimming control voltage is produced by means of an RC integrating filter supplied by a square wave signal. The square wave signal is generated by the micro controller, which generates a fixed frequency signal with four separate duty cycle modes. The higher the duty cycle, the higher the resulting filtered DC dimming control voltage (Figure 4.1).

The GP1 input of the micro controller IC2 is also connected to the AC line input voltage through a filter circuit with a very short delay. This allows IC2 to detect very rapidly when AC power has been removed and restored. The 5V VDD supply storage capacitor C1 is sufficiently large to allow IC2 to continue to run for more than one second after AC power has been removed from the ballast. When the AC line is switched off, IC2 detects this rapidly and starts a timer from this point. If power is restored within one second, the dimming level is reduced by one level, thus reducing the output square wave duty cycle and reducing the dimming level by one step. If the dimming level was already at minimum then it will cycle back to maximum. In the case of AC power being removed for more than one second the dimming level will not be changed. After C1 has discharged below the minimum VDD operating voltage of IC2 the micro controller will shut off.

The micro controller that has been used here is a [PIC12F629](#), which contains some EEPROM non-volatile memory. The EEPROM allows the micro to store the last dim level

setting before shutting down when power is switched off, therefore allowing the ballast start up at that same setting when power is restored, no matter how long the ballast has been off. For the [micro controller code](#), please refer to the CD that comes with the reference design kit. There are of course several alternative low cost micro controllers that could be used equally well to realize this kind of ballast and that contain the same functionality.

Figure 4.1 shows the microcontroller PWM outputs for all 4 dimming level.

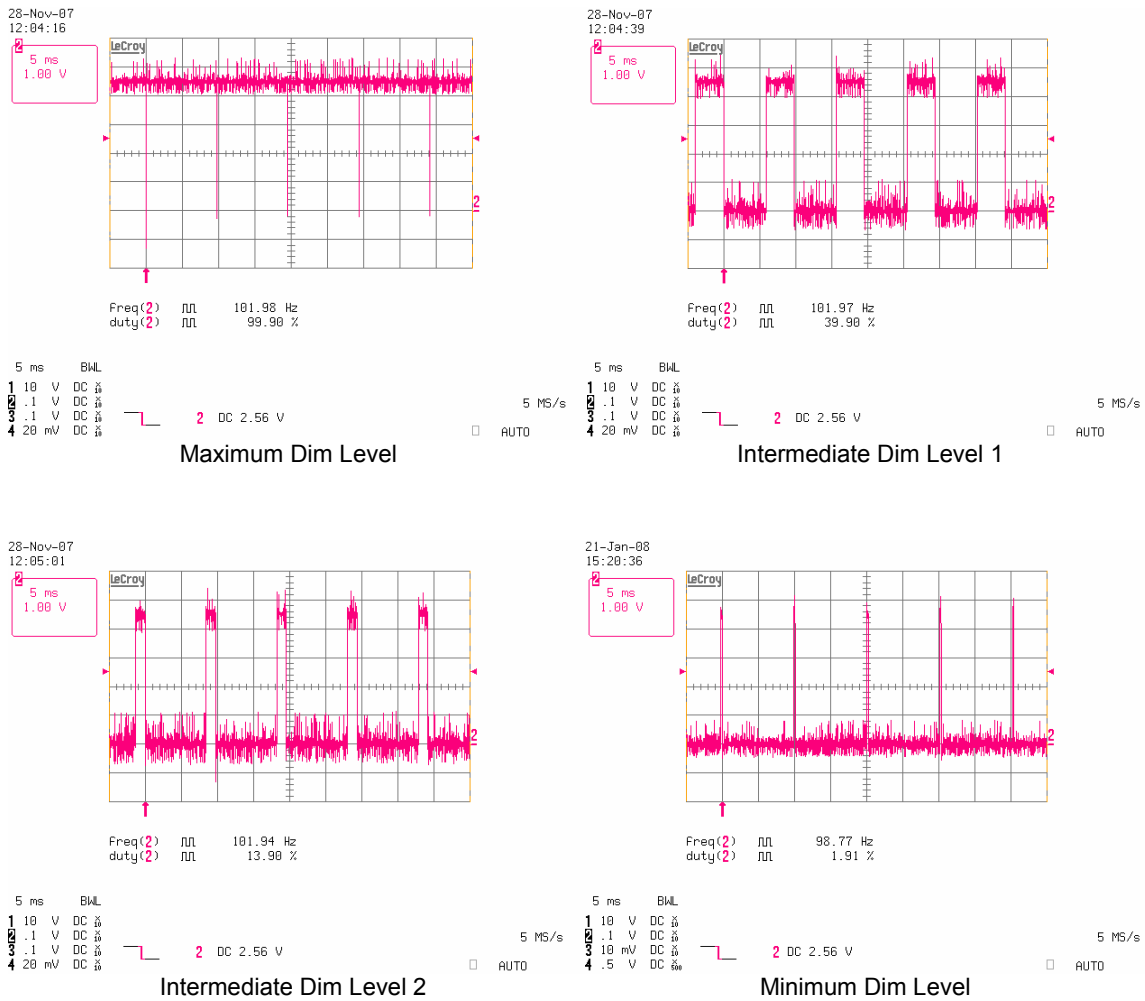

Figure 4.1: Microcontroller PWM Outputs

Figure 4.2 shows the voltage at the DIM pin for all 4 dimming level.

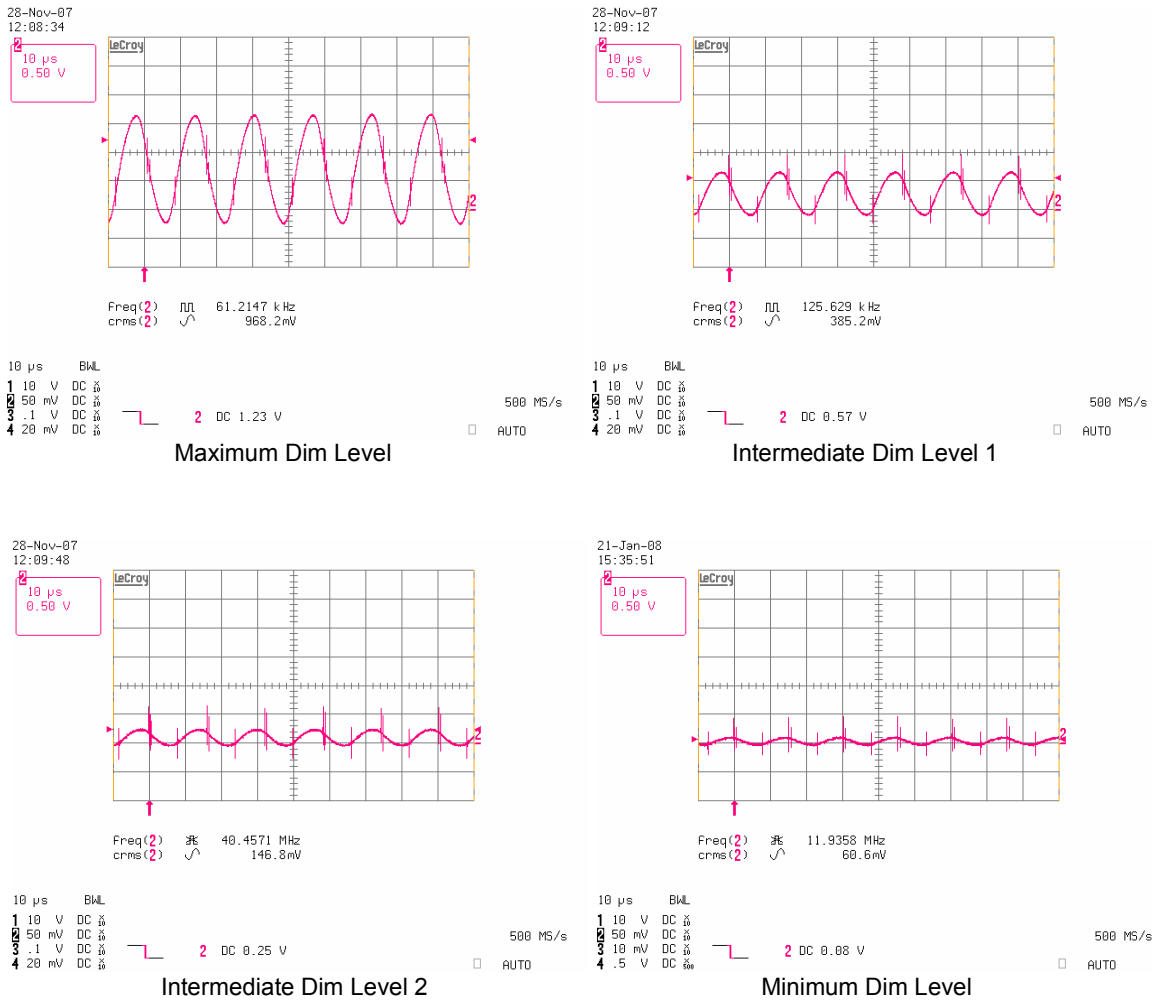

Figure 4.2: IRS2530D DIM pin voltages

Figure 4.3 shows the voltage at the VCO pin, and the VS (half-bridge) voltage for all 4 dimming level.

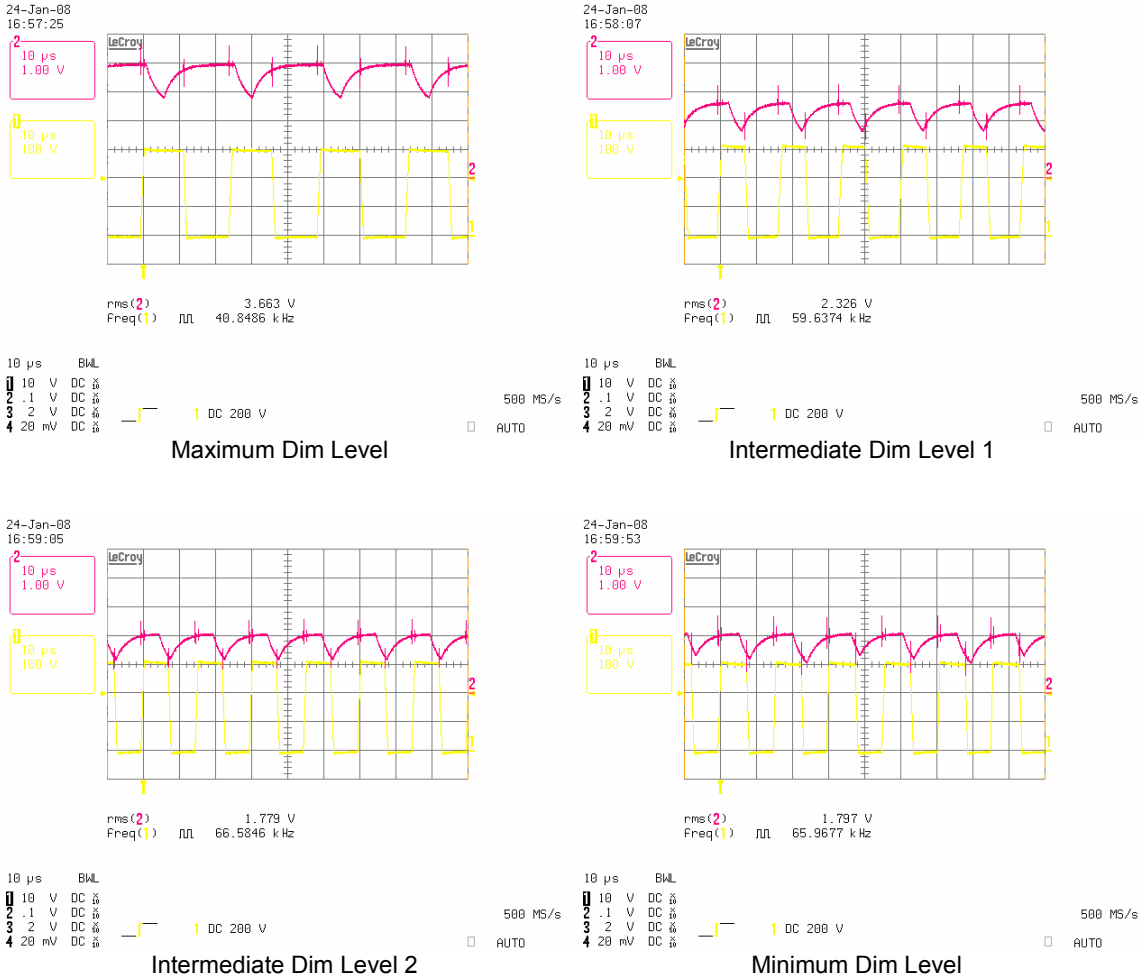

Figure 4.3: IRS2530D VCO (red) and VS (yellow) pin voltages

Figure 4.4 shows the voltage across the lamp, and the current through the lamp for all 4 dimming level.

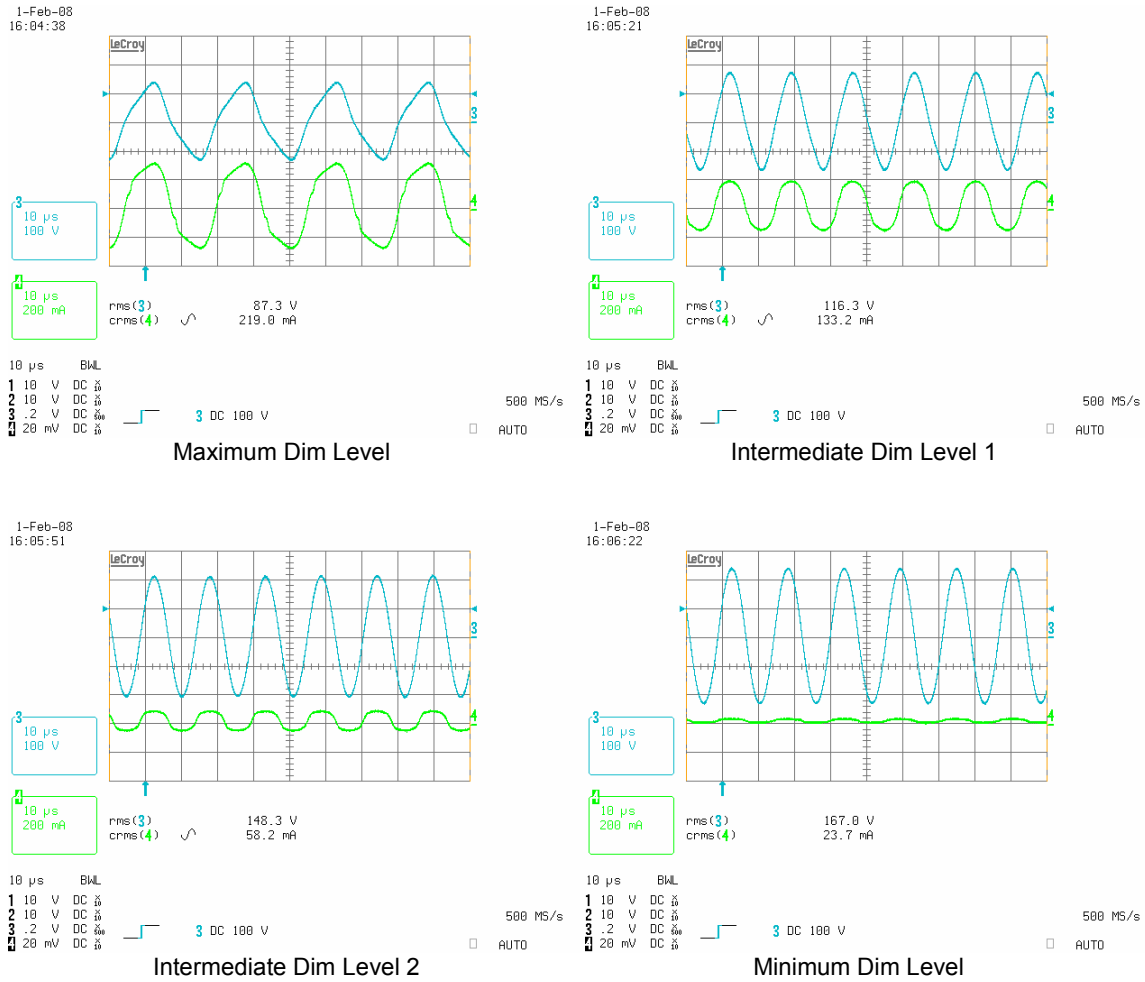

Figure 4.4: Lamp Voltage and Arc Current

25-Jan-08
12:41:01

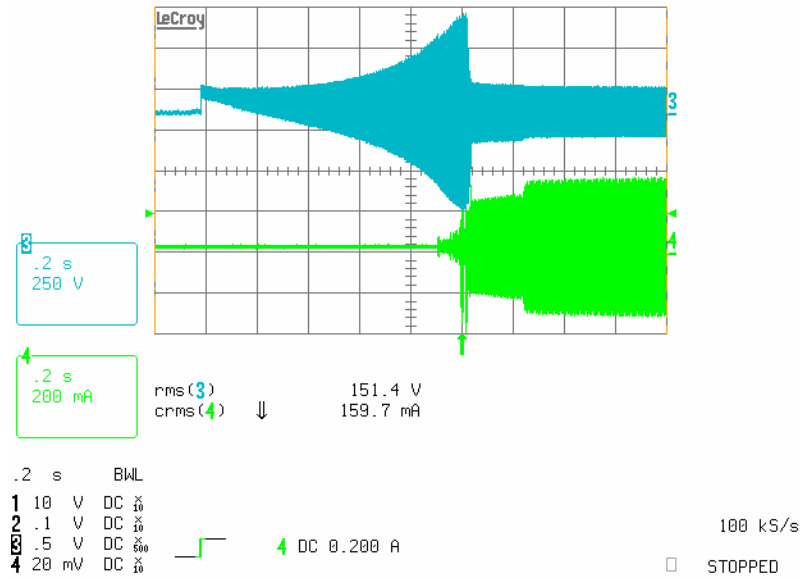

Figure 4.5: Lamp Voltage and Arc Current during preheat and ignition

It should be noted in this example that the VCO voltage and consequently the ballast frequency varies only by quite a small amount between the four different dimming levels, although the lamp arc current varies considerably. This is because the system is operating above the point in the dimming response curve known as the "knee", this is illustrated below.

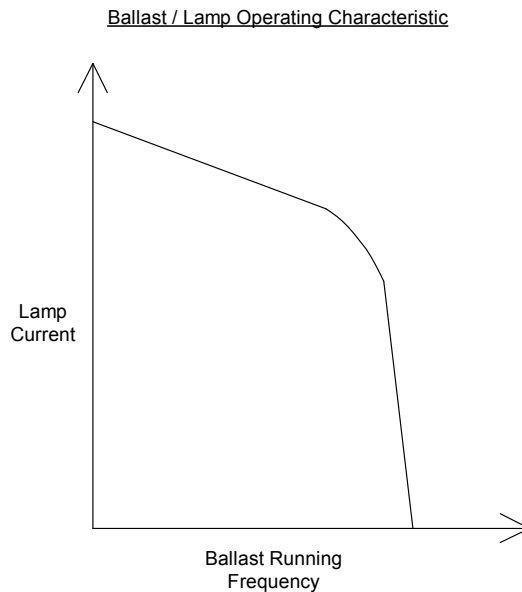

Figure 4.6: Lamp current against ballast frequency

R6 is also required in order to ensure that the DIM pin of IC1 will be biased above 0V before the voltage at VCC exceeds the UV+ threshold at startup. This prevents the IRS2530D from shutting down during the first few cycles of hard switching that occur when the half bridge starts to oscillate at maximum frequency.

5. Fault Conditions

In case of fault conditions such as open filaments, failure to strike, or lamp removal, the IRS2530D will go into Fault Mode. In this mode, the internal fault latch is set, HO is off, LO is open circuit, and the IRS2530D consumes an ultra-low micro-power current. The IRS2530D can be reset with a lamp exchange (as detected by the LO pin) or a recycling of VCC below and back above the UVLO thresholds.

Failure to Strike

At initial turn-on of the ballast, the frequency will ramp down from f_{MAX} toward the resonance frequency. When the lamp fails to strike, the VCO voltage continues to increase and the frequency continues to decrease until the VCO voltage exceeds $VVCOFLT+$ (4.0V, typical), and the IRS2530D enters Fault Mode and shuts down (Figure 5.1). It should be noted that in case of failure to strike, the system will operate in capacitive side of resonance, but only for short period of time.

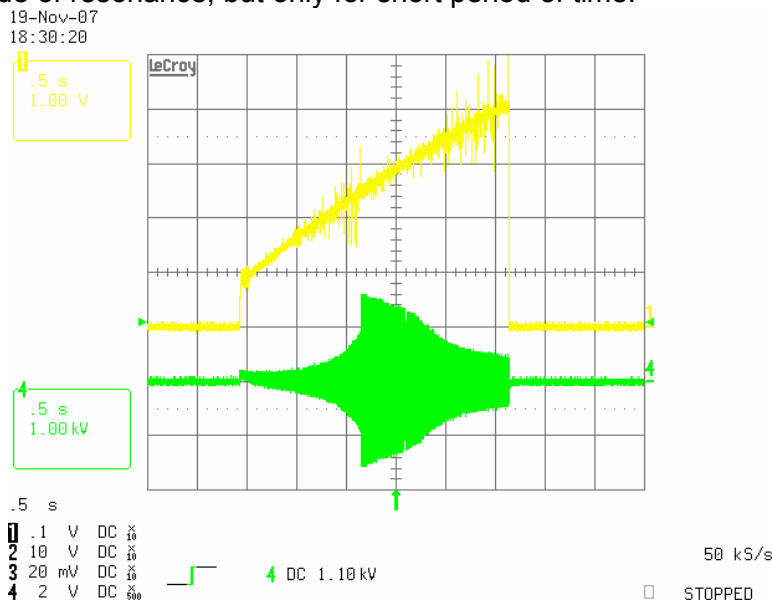

Figure 5.1: Lamp non-strike: CH1 is the VCO voltage, CH4 is the voltage across lamp

AC Mains Interrupt / Brown-Out Conditions

This protection relies on the non-ZVS circuit of IRS2530D, enabled in the Dim Mode. During an AC mains interrupt or brown-out condition, the DC bus can decrease and cause the system to operate too close to, or, on [the] capacitive side of resonance. The result is non-ZVS switching that causes high peak currents to flow in the half-bridge MOSFETs that can damage or destroy them.

To protect against this, the IRS2530D will detect non-ZVS by measuring the VS voltage at each rising edge of LO. If the voltage is greater than $VZVSTH$ (4.5V, typical), the IC will reduce the voltage at VCO pin, and thus increase the frequency until ZVS is reached again (Figure 5.2).

In case the DC bus decreases too far and the lamp extinguishes, the VCC voltage will go below VCCUV- and the ignition/preheat ramp will be reset to re-ignite the lamp reliably.

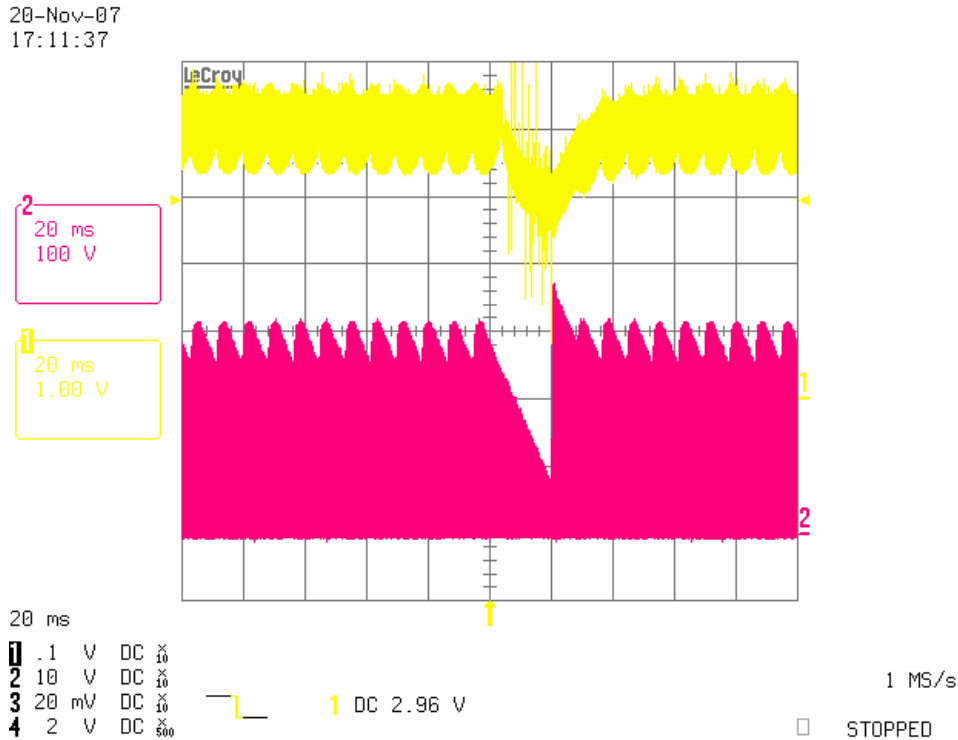

Figure 5.2: Brown-out conditions: CH1 is the VCO voltage, CH2 is the VS voltage

Lamp Removal

When the lamp is removed, the IRS2530D uses the Crest Factor Over-current Protection to enter the Fault mode and shut down. During lamp removal, the output stage will transition to a series-LC configuration, and the frequency will move towards resonance until the inductor saturates. The IRS2530D uses the VS-sensing circuitry and the RDSon of the low-side half-bridge MOSFET to measure the MOSFET current for detecting an over-current fault. Should the peak current exceed the average current by a factor of 5.5 ($CF > 5.5$) during the on-time of LO, the IRS2530D will enter Fault Mode, where the half-bridge is off. Performing crest factor measurement provides a relative current measurement that cancels temperature and/or tolerance variations of the RDSon of the low-side half-bridge MOSFET.

Figure 5.3 shows the voltage across the lamp and the VS voltage when the lower filament of the lamp is removed. Figure 5.4 shows these voltages when the upper filament of the lamp is removed. In both cases, the IRS2530D will enter the Fault Mode and shut down after detecting that the crest factor exceeds 5 during the on-time of LO. Figure 5.5 shows the VS pin, inductor current, and voltage across lamp when the inductor saturates and the ballast shuts down.

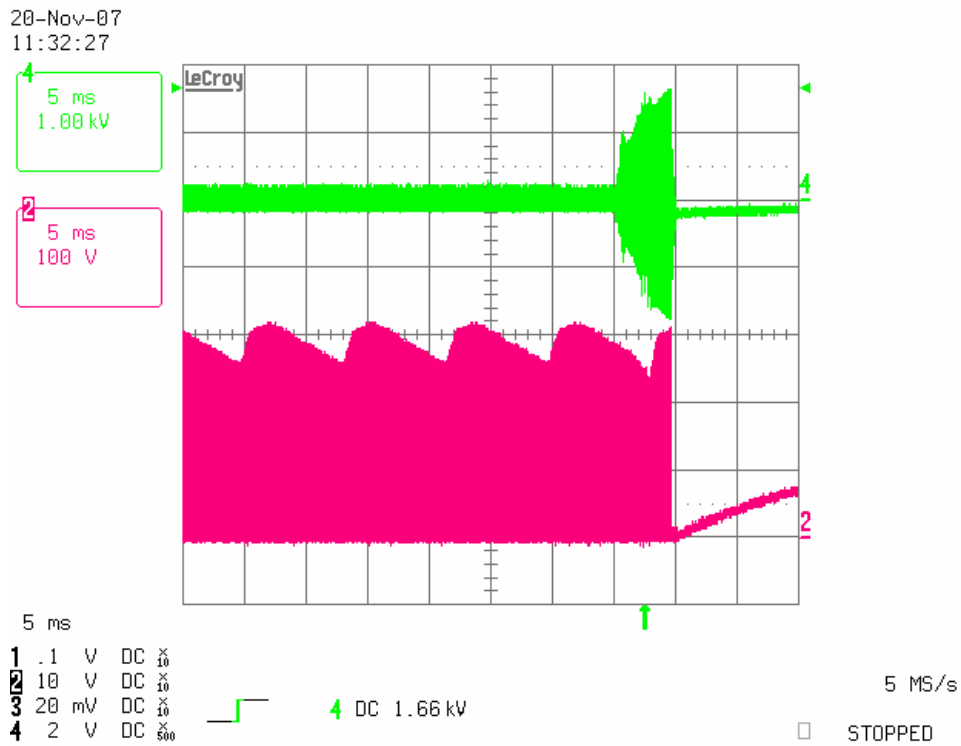

Figure 5.3: Lower filament removed: CH2 is the VS voltage, CH4 is the voltage across the lamp

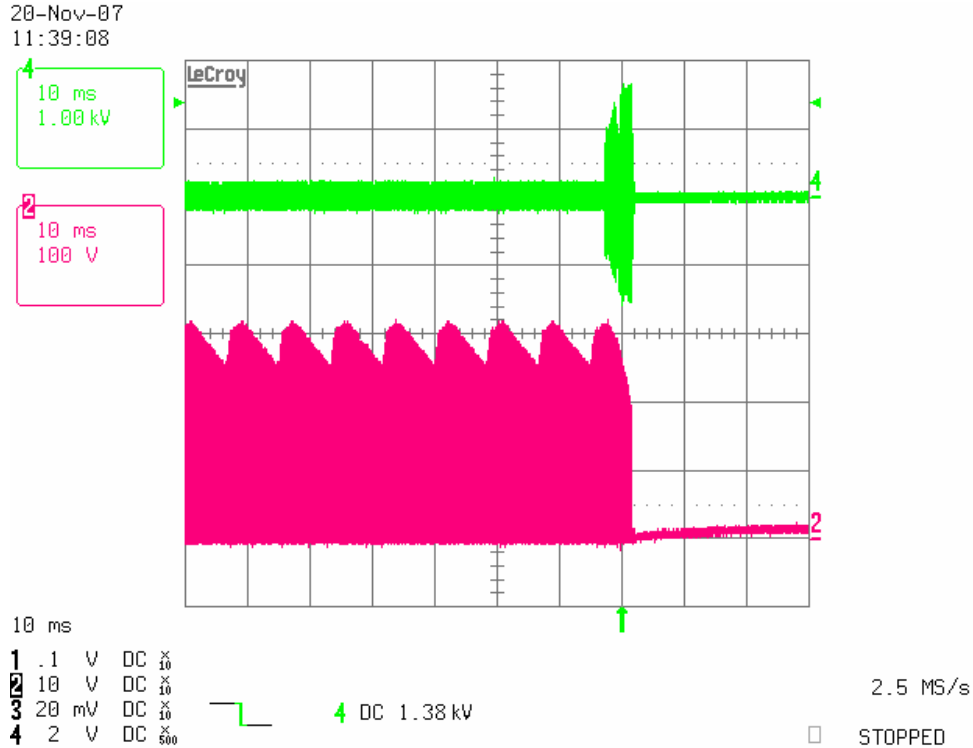

Figure 5.4: Upper filament removed: CH2 is the VS voltage, CH4 is the voltage across the lamp

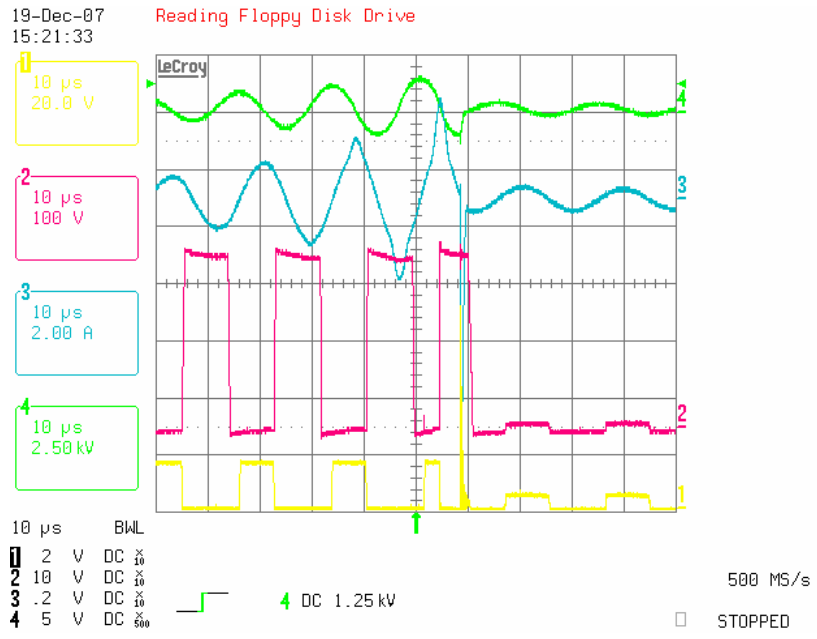

Figure 5.5: Inductor saturation: CH1 is the LO voltage, CH2 is the VS voltage, CH3 is the current through the resonant inductor, and CH4 is the voltage across the lamp

Figure 5.6 shows the VS voltage and the voltage across the lamp when the IC undergoes reset with a lamp exchange. When the lamp is removed, crest factor protection is triggered, and the IC enters the Fault mode and shuts down. Since the lamp is removed, LO pins is pulled above VLOSD+, and the IC goes to UVLO mode. When the lamp is re-inserted, the IC goes back to the Preheat / Ignition mode, and the half-bridge starts to oscillate again.

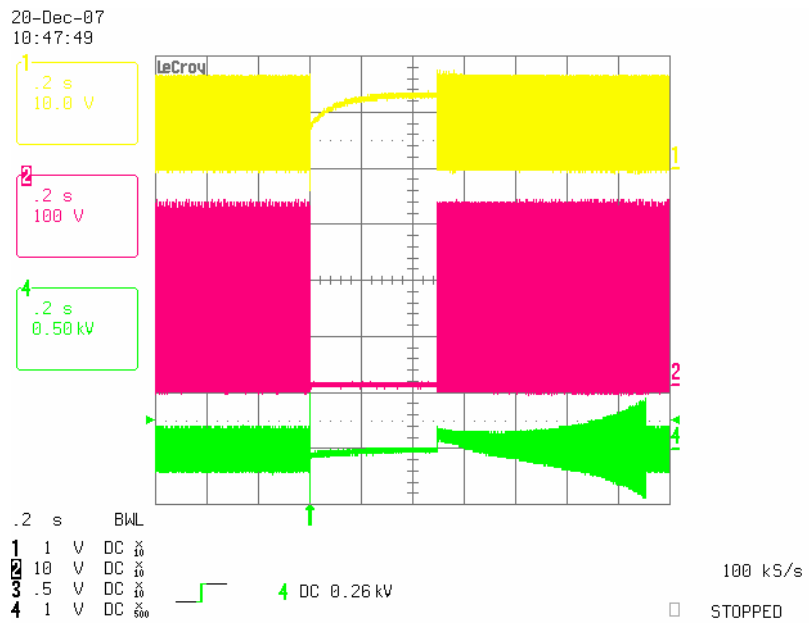

Figure 5.6: Lamp exchange: CH1 is the LO voltage, CH2 is the VS voltage, and CH4 is the voltage across the lamp

6. Bill of Materials

Item #	Qty	Manufacturer	Part Number	Description	Reference
1	1	IR	IRS2530D	Dimming Ballast Control IC	IC1
2	1	Microchip	PIC12F629	8 pin DIP μ Controller	IC2
3	2	IR	IRFU320	Transistor, MOSFET, 400V	MHS, MLS
4	1	Digi-key	RH06DICT-ND	Bridge Rectifier, 0.5A 600V, miniDIP	BR1
5	1	Diodes Inc	ZMM5247B-7	Diode, Zener 17V, 500mW, MiniMelf	DCP1
6	1	Diodes Inc	LL4148DICT-ND	Diode, 75V, 100mA DL35	DCP2
7	2	Diodes Inc	ZMM5231B-7	Diode, Zener 5.1V, 500mW MiniMelf	D1 D2
8	1	Diodes Inc	MURS160-13	Diode, 600V, 1A, SMB	DIN
9	1	Digi-key	M8301-ND	Inductor, 1mH, 200mA	LF
10	1	Vogt	IL 070 503 11 02	Inductor, 2.3mH, EF20	LRES
11	1	Panasonic	ECA-0JHG331	Capacitor, 330 μ F, 6.3V, 105C, Radial	C1
12	1	Panasonic	ECJ-3YB1E225K	Capacitor, 2.2 μ F, 25V, 1206	C6
13	1	Wima	MKS2 Series	Capacitor, 47nF, 400V	CDC
14	1	Digi-key	P10730-ND	Capacitor 0.1 μ F, 275VAC	CF
15	1	Panasonic	EEU-EB2V100	Capacitor, 10 μ F, 350V, 105C, Radial	CBUS
16	6	Panasonic	ECJ-3VB1H104K	Capacitor, 0.1 μ F, 50V, 1206	CBS, CFB, CH1, CH2, C2, C7
17	1	Panasonic	ECU-V1H222KBM	Capacitor, 2.2nF, 50V, 1206	CVCO
18	1	Panasonic	ECJ-3YB1E684K	Capacitor, 0.68 μ F, 25V, 1206	CPH
19	1	Panasonic	ECJ-3YB1E105K	Capacitor, 1 μ F, 25V, 1206	CVCC
20	2	Panasonic	CC1206KRX7R9B B103	Capacitor, 10nF, 50V, 1206	C3, CDIM
21	1	Panasonic	ECK-D3A102KBP	Capacitor, 1nF, 1KV, Ceramic disk	CVS
22	1	Wima TAW	MKP10 Series MKP472K1K6	Capacitor, 4.7nF, 1600V Polypropylene	CRES
23	0		NOT FITTED		CLO
24	1	Panasonic	ERJ-8GEYJ106V	Resistor, 10M, 0.25W, 1206	R6
25	2	Panasonic	ERJ-8GEYJ154V	Resistor, 150K, 0.25W, 1206	R1, R2
26	1	Panasonic	ERJ-8GEYJ124V	Resistor, 120K, 0.25W, 1206	R3
27	1	Panasonic	ERO-S2PHF1203	Resistor 120K, 0.25W, Axial	R4
28	1	Panasonic	ERJ-8GEYJ243V	Resistor, 24K, 0.25W, 1206	R5
29	2	Panasonic	ERJ-8GEYJ364V	Resistor, 360K, 0.25W, 1206	RVCC1, RVCC2
30	1	Panasonic	ERD-S2TJ7R5V	Resistor, 7.5 Ohm, 5%, 0.5W, Axial	RCS
31	1	Panasonic	ERJ-8GEYJ474V	Resistor, 470K, 0.25W, 1206	RLMP1
32	1	Panasonic	ERJ-8GEYJ105V	Resistor, 1M, 0.25W, 1206	RLMP2
33	3	Panasonic	ERJ-8GEYJ104V	Resistor, 100K, 0.25W, 1206	R7, R9, R10
34	1	Panasonic	ERJ-8GEYJ563V	Resistor, 56K, 0.25W, 1206	R8
35	1	Panasonic	ERJ-8GEYJ102V	Resistor, 1K, 0.25W, 1206	RFB
36	1	Panasonic	ERJ-8GEYJ152V	Resistor, 1.5K, 0.25W, 1206	RVCO
37	2	Panasonic	ERJ-8GEYJ100V	Resistor, 10 Ohm, 0.25W, 1206	RHO, RLO
38	1	Vishay/BC	NFR25H0004707J R500	Resistor, 0.47R, 1/2W	F1
39	1			Wire Jumper	J1
40	1	Wago	235-202	Connector, 2 terminal	X1
41	1	Wago	235-204	Connector, 4 terminal	X2
42	6	Digi-key	5000K-ND	Test Point	VCC, COM, LO, VCO, DIM, VLAMP, VS
43	1		IRPLDIM5E_Rev2	PCB, Single Layer	

TABLE 6.1: IRPLDIM5E Bill of Materials.

7. IRPLDIM5E PCB Layout

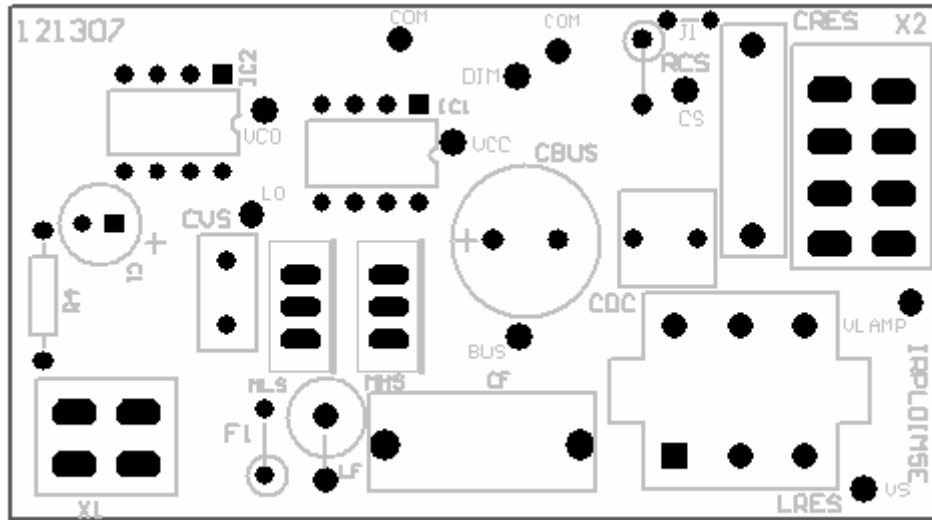

Top Assembly

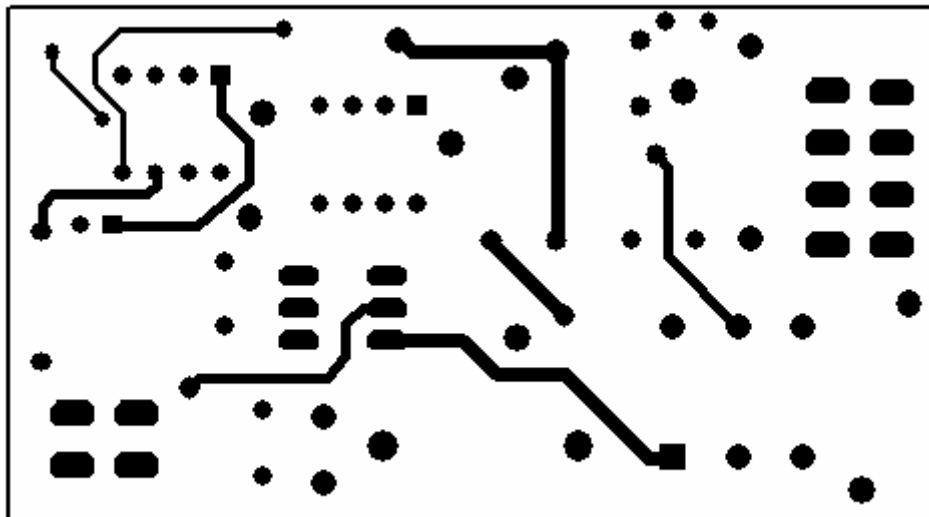

Top Copper

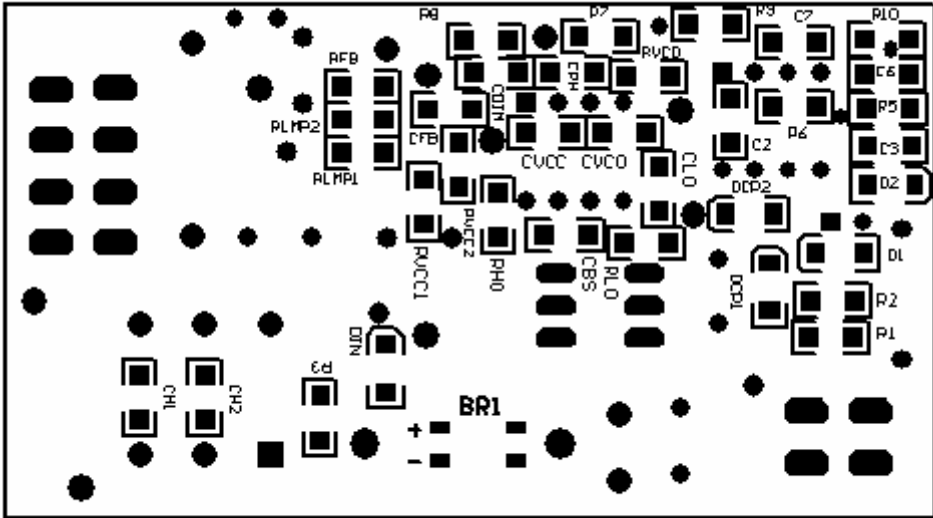

Bottom Assembly

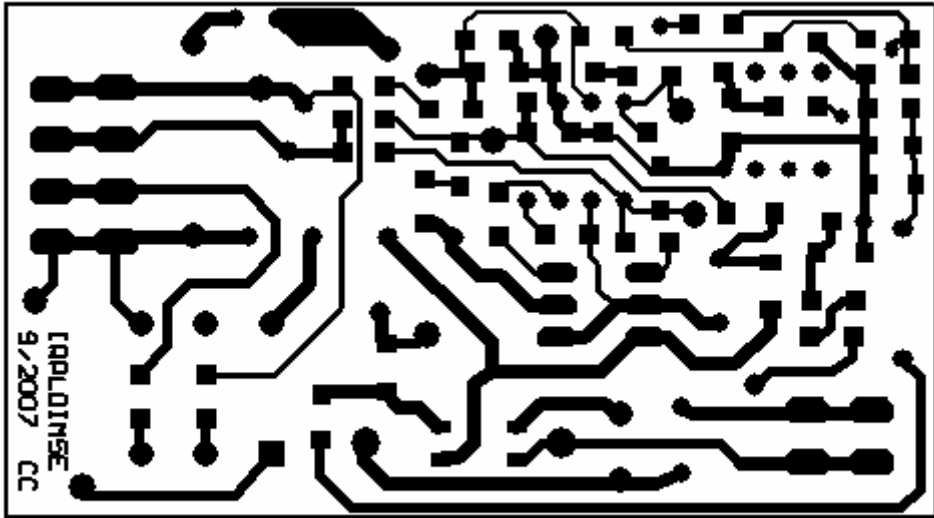

Bottom Copper

8. Inductor Specifications

Vogt # IL 070 503 11 02
BI Technologies # HM00-07544



INDUCTOR SPECIFICATION

CORE SIZE

GAP LENGTH mm

CORE MATERIAL

NOMINAL INDUCTANCE mH

TEST TEMPERATURE C

WINDING	START PIN	FINISH PIN	TURNS	WIRE DIAMETER (mm)
MAIN	1	6	240*	10/ 38 Multistranded
CATHODE	2	5	5.5	26 awg insulated
CATHODE	3	4	5.5	26 awg insulated

PHYSICAL LAYOUT
(Vertical6- Pin Bobbin)

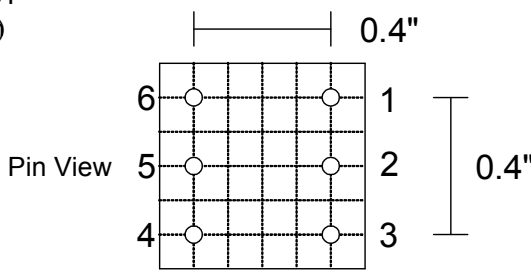

TEST TEST TEMPERATURE C

MAIN WINDING INDUCTANCE mH

* Adjust turns for specified Inductance mH