

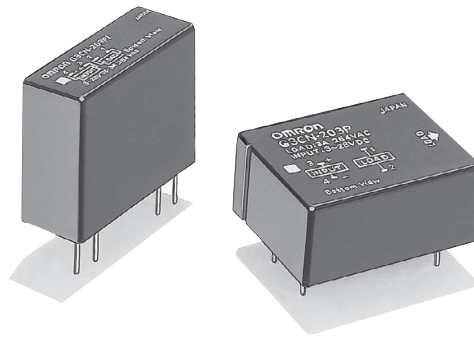

PCB-mounting SSR for FA Equipment Requiring High Reliability

- 3 to 28 VDC input and 75 to 264 VAC output.
- Wide I/O voltage range: 3 to 28 VDC input and 3 to 52.8 VDC output.
- Two load currents available: 2 A and 3 A
- Flat and vertical models available for a variety of applications.



RoHS Compliant

Refer to "Solid State Relays Common Precautions".

List of Models

Isolation	Zero cross function	Indicator	Rated output load	Rated input voltage	Model	Minimum packing unit
Photocoupler	Yes	No	2 A at 100 to 240 VAC	4 to 24 VDC	G3CN-202P	10 pcs
			3 A at 100 to 240 VAC		G3CN-202P1 *1	20 pcs
					G3CN-203P	10 pcs
					G3CN-203P1 *1	20 pcs
Phototriac	No		2 A at 100 to 240 VAC	5 VDC 12 VDC 24 VDC *2	G3CN-202PL	10 pcs
			3 A at 100 to 240 VAC		G3CN-202PL1 *1	20 pcs
					G3CN-203PL	10 pcs
					G3CN-203PL1 *1	20 pcs
Photocoupler	-	2 A at 4 to 48 VDC	4 to 24 VDC	G3CN-DX02P	10 pcs	
		3 A at 4 to 48 VDC		G3CN-DX02P1 *1	20 pcs	
				G3CN-DX03P	10 pcs	
				G3CN-DX03P1 *1	20 pcs	

Note: Refer to the "List of Certified Models" for UL, CSA, and EN approved models. *1. These are vertical types. *2 When ordering, specify the input voltage.

Ratings

Input

Model	Item	Rated voltage	Operating voltage	Input impedance	Voltage level	
					Must operate voltage	Must release voltage
G3CN-202P(1) G3CN-203P(1)		4 to 24 VDC	3 to 28 VDC	1.5 kΩ ^{+20%} / _{-10%}	3 VDC max.	1 VDC min.
G3CN-202PL(1) G3CN-203PL(1)		5 VDC	4 to 6 VDC	390 Ω ±20%	4 VDC max.	
		12 VDC	9.6 to 14.4 VDC	900 Ω ±20%	9.6 VDC max.	
		24 VDC	19.2 to 28.8 VDC	2 kΩ ±20%	19.2 VDC max.	
G3CN-DX02P(1) G3CN-DX03P(1)		4 to 24 VDC	3 to 28 VDC	1.5 kΩ ^{+20%} / _{-10%}	3 VDC max.	

Output

Model	Item	Applicable load			
		Rated load voltage	Load voltage range	Load current	Inrush current
G3CN-202P(1) G3CN-202PL(1)		100 to 240 VAC	75 to 264 VAC	0.1 to 2 A *	30 A (60 Hz, 1 cycle)
G3CN-203P(1) G3CN-203PL(1)				0.1 to 3 A *	
G3CN-DX02P(1) G3CN-DX03P(1)		4 to 48 VDC	3 to 52.8 VDC	0.1 to 2 A *	12 A (10 ms)
				0.1 to 3 A *	18 A (10 ms)

Note. The input impedance values are the maximum values of applied voltage. (measured at 28 VDC for 4 to 24 VDC models)

* The applicable output load current varies depending on the ambient temperature. Consult your Omron sales representative for details.

Characteristics

Model	Item	G3CN-202P(1), G3CN-203P(1)	G3CN-202PL(1), G3CN-203PL(1)	G3CN-DX02P(1), G3CN-DX03P(1)
Operate time		1/2 of load power source cycle + 1 ms max.	1 ms max.	0.5 ms max.
Release time		1/2 of load power source cycle + 1 ms max.	1/2 of load power source cycle + 1 ms max.	2 ms max.
Output ON voltage drop		1.6 V (RMS) max.		1.5 V max.
Leakage current		5 mA max. (at 100 VAC) 10 mA max. (at 200 VAC)	2.5 mA max. (at 100 VAC) 5 mA max. (at 200 VAC)	5 mA max. (at 50 VDC)
Insulation resistance		100 MΩ min. (at 500 VDC)		
Dielectric strength		2,500 VAC, 50/60 Hz for 1 min between input and output		
Vibration resistance		10 to 55 to 10 Hz, 0.75-mm single amplitude (1.5-mm double amplitude)		
Shock resistance		1,000 m/s ²		
Ambient Operating temperature		-30°C to 80°C (with no icing nor condensation)		
Ambient Operating humidity		45% to 85%RH		
Storage Temperature		-30°C to 100°C (with no icing nor condensation)		
Weight		Approx. 25 g		

Engineering Data

● Load Current vs. Ambient Temperature Characteristics G3CN-202P(1), G3CN-202PL(1), G3CN-DX02P(1)

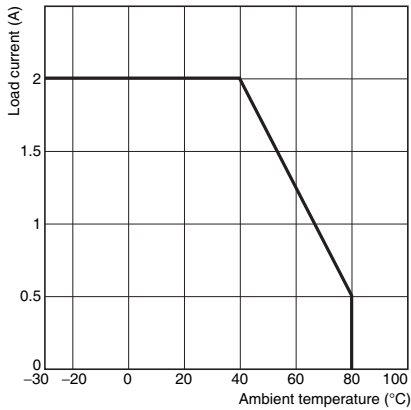

● One Cycle Surge Current: Non-repetitive Non-repetitive (Keep the inrush current to half the rated value if it occurs repetitively.) 2-A Load Model G3CN-202P(1), G3CN-202PL(1)

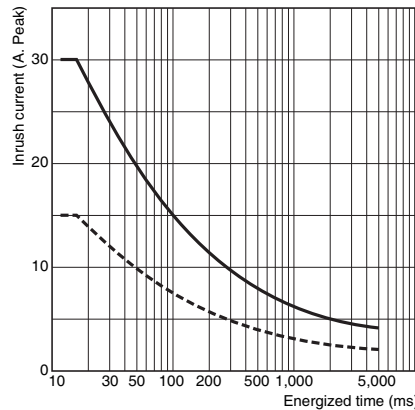

G3CN-DX02P(1)

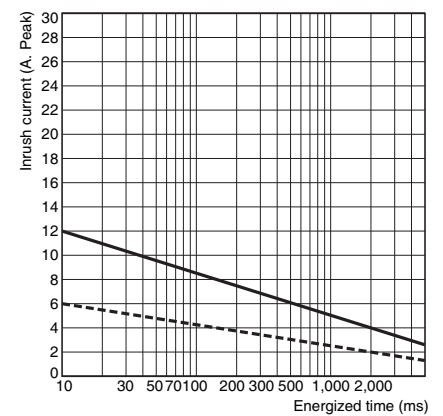

G3CN-203P(1), G3CN-203PL(1), G3CN-DX03P(1)

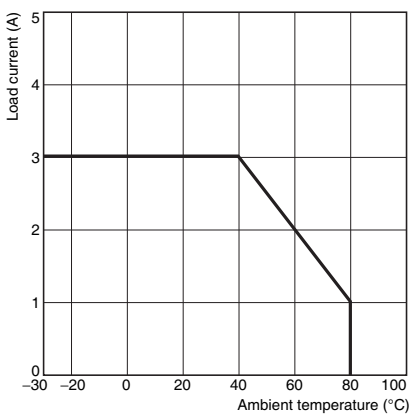

3-A Load Model G3CN-203P(1), G3CN-203PL(1)

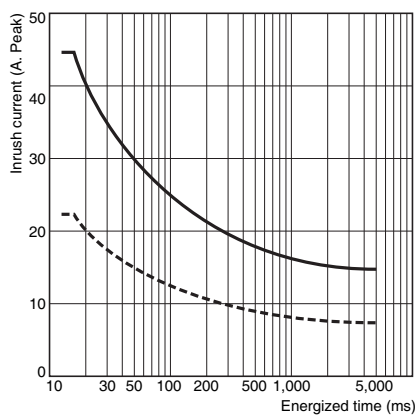

G3CN-DX03P(1)

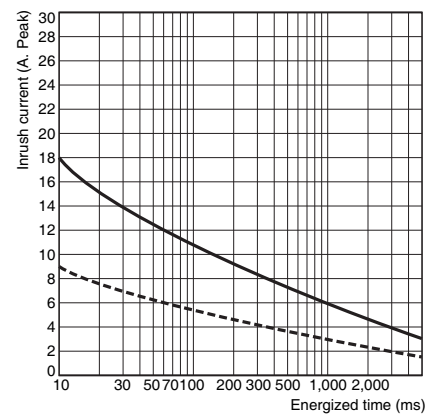

Dimensions

(Unit: mm)

● Flat Model

G3CN-20□P
G3CN-20□PL
G3CN-DX0□P

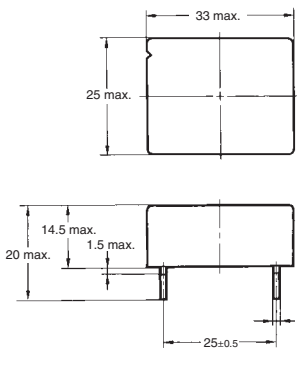
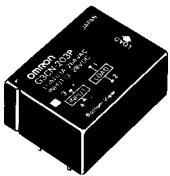

Mounting Holes
Tolerance: ±0.1 mm unless specified
(BOTTOM VIEW)

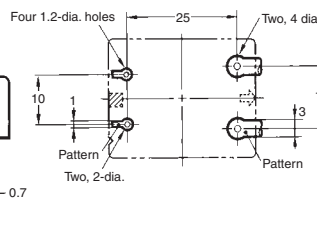

**Terminal Arrangement/
Internal Connections**
(BOTTOM VIEW)

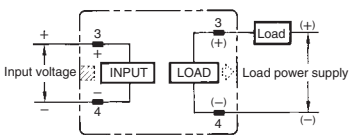

Note. The plus and minus symbols shown in the parentheses are for DC loads.

● Vertical Model

G3CN-20□P1
G3CN-20□PL1
G3CN-DX0□P1

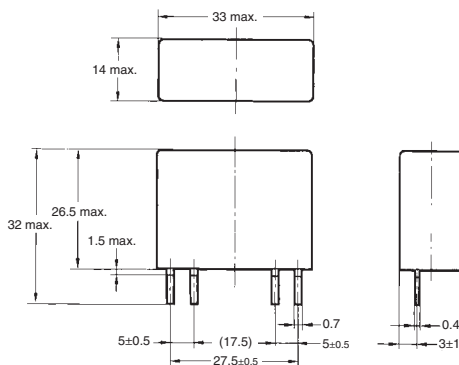
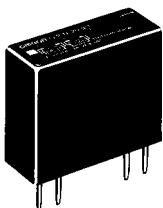

Mounting Holes
Tolerance: ±0.1 mm unless specified
(BOTTOM VIEW)

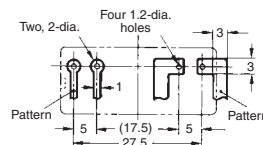

**Terminal Arrangement/
Internal Connections**
(BOTTOM VIEW)

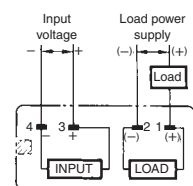

Note. The plus and minus symbols shown in the parentheses are for DC loads.

Precautions

● Please refer to "Solid State Relays Common Precautions" for correct use.

- Application examples provided in this document are for reference only. In actual applications, confirm equipment functions and safety before using the product.
- Consult your OMRON representative before using the product under conditions which are not described in the manual or applying the product to nuclear control systems, railroad systems, aviation systems, vehicles, combustion systems, medical equipment, amusement machines, safety equipment, and other systems or equipment that may have a serious influence on lives and property if used improperly. Make sure that the ratings and performance characteristics of the product provide a margin of safety for the system or equipment, and be sure to provide the system or equipment with double safety mechanisms.

Note: Do not use this document to operate the Unit.