

High-density mounting and speedy termination are possible with the XG2.

- IDC connections allow you to wire all terminals at once without terminating the cable.
- Can be DIP-soldered directly to the circuit board.
- Small size (height 5.8 mm, width 6.8 mm) allows more efficient use of circuit board space.
- Uses a 2.54-mm grid terminal arrangement for easier design of circuits.
- Type: standard and reverse.
- Uses UL94V-0 approved insulation material.
- The IDC Tool has Attachments for all terminals. The result is efficient, labor-saving wiring.

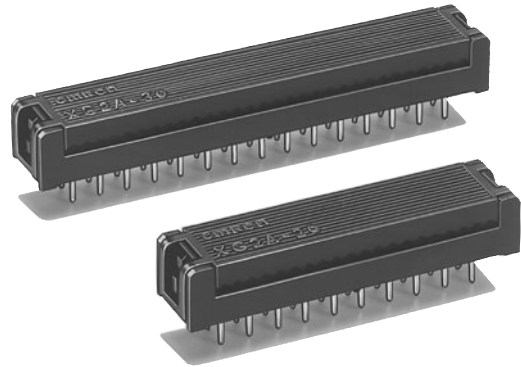

RoHS Compliant

### Terminal Arrangement

The contact numbers are not marked on the Connector. If the cables are numbered from 1 starting from the edge, the relationship between the wires and the terminals would be as shown at the right.

Standard Terminal Arrangement

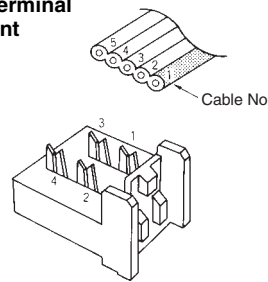

Reverse Terminal Arrangement

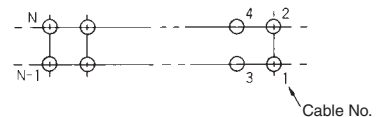
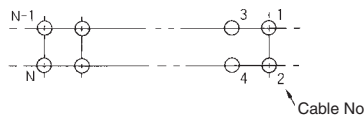
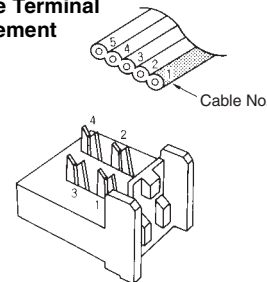

Cable number arrangement (top view)

### Ratings and Characteristics

Rated current	1 A
Rated voltage	250 VAC
Contact resistance	15 mΩ max. (at 20 mV, 100 mA max.)
Insulation resistance	1,000 MΩ min. (at 500 VDC)
Dielectric strength	500 VAC for 1 min (leakage current: 1 mA max.)
Ambient operating temperature	-55 to 85°C (with no icing at low temperature)

### Cross-sectional View of Terminal

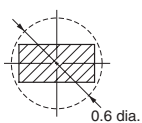

### Materials and Finish

Base		Fiber-glass reinforced PBT resin (UL94V-0)/black
Contacts	Mating end	Copper alloy/nickel base, 2.0-μm tin plating
	Terminals	Copper alloy/nickel base, 2.0-μm tin plating
Cover		Fiber-glass reinforced PBT resin (UL94V-0)/black

### Applicable Wires

- 1.27-mm pitch, AWG28, 7-strand flat cable.
- UL2651 (standard cable)
  - UL20012 (folding cable)
  - UL20028 (color-coded cable)

# XG2A Double-row PCB Connectors

## ■ Dimensions

(Unit: mm)

Standard Terminal Arrangement: XG2A-□□01

Reverse Terminal Arrangement: XG2A-□□02

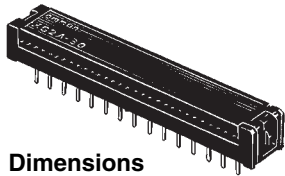

Dimensions

No. of contacts	Dimensions (mm)	
	A	B
10	17.9	10.16
14	22.9	15.24
16	25.5	17.78
20	30.6	22.86
26	38.2	30.46
30	43.3	35.56
34	48.3	40.64
40	56.0	48.26
50	68.7	60.96
60	81.4	73.66
64	86.4	78.74

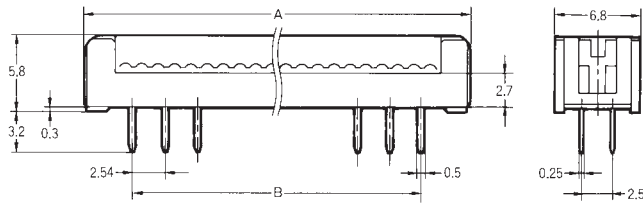

Mounting holes (bottom view)

Standard terminal arrangement

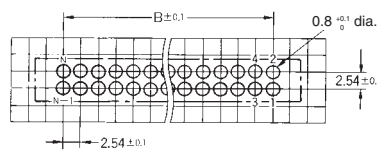

Reverse terminal arrangement

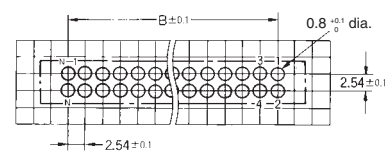

## ■ Ordering Information

Appearance		
No. of contacts	Connectors with standard terminal arrangement	Connectors with reverse terminal arrangement
10	XG2A-1001	XG2A-1002
14	XG2A-1401	XG2A-1402
16	XG2A-1601	XG2A-1602
20	XG2A-2001	XG2A-2002
26	XG2A-2601	XG2A-2602
30	XG2A-3001	XG2A-3002
34	XG2A-3401	XG2A-3402
40	XG2A-4001	XG2A-4002
50	XG2A-5001	XG2A-5002
60	XG2A-6001	XG2A-6002
64	XG2A-6401	XG2A-6402

Note: The cover is an open-end type.

## ■ Precautions

### Correct Use

#### Handling

- There is no Strain Relief for the PCB Connector. Leave enough slack to avoid tension on the cable.
- Terminals can be press fit no matter which direction the base and cover are facing.

- See the pages on the XG4 or XG2 connector for information on special tools, such as IDC press tools.

### Automated Soldering Conditions (Jet Flow)

1. Soldering temperature: 250 ±5°C
2. Continuous soldering time: Within 5 s

# XY3A Flat Cable (UL-approved Wires)

## ■ Dimensions

(Unit: mm)

**XY3A-□□01**  
Standard Cables

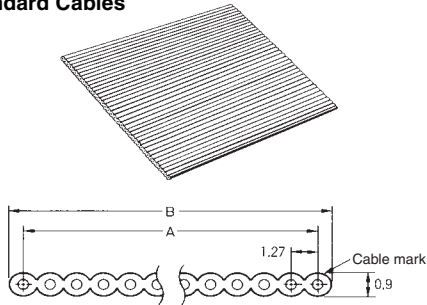

**XY3A-□□02**  
Folding Cables

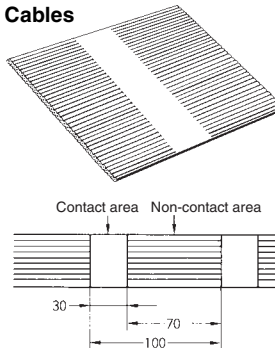

**XY3A-□□03**  
Color-coded Cables

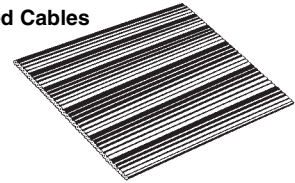

Core No.	Insulation color	Core No.	Insulation color
1	Brown	6	Blue
2	Red	7	Purple
3	Orange	8	Gray
4	Yellow	9	White
5	Green	10	Black

**Note:** The colors above repeat again from 11 cores.

## ■ Ordering Information (Order in 1-roll (61.0 m) units)

No. of cores	Standard Cable	Folding Cable (See note.)	Color-coded Cable	Dimensions (mm)		Applicable Connector		
				A	B	MIL	IDC Plug	PCB
10	XY3A-1001	XY3A-1002	XY3A-1003	11.4	12.7	XG4M-10□□	XG4E-10□□	XG2A-100□
14	XY3A-1401	XY3A-1402	XY3A-1403	16.5	17.8	XG4M-1430	XG4E-143□	XG2A-140□
16	XY3A-1601	XY3A-1602	XY3A-1603	19.1	20.3	XG4M-1630	XG4E-163□	XG2A-160□
20	XY3A-2001	XY3A-2002	XY3A-2003	24.1	25.4	XG4M-2030	XG4E-203□	XG2A-200□
26	XY3A-2601	XY3A-2602	XY3A-2603	31.8	33.0	XG4M-2630	XG4E-263□	XG2A-260□
30	XY3A-3001	XY3A-3002	XY3A-3003	36.8	38.1	XG4M-3030	XG4E-303□	XG2A-300□
34	XY3A-3401	XY3A-3402	XY3A-3403	41.9	43.2	XG4M-3430	XG4E-343□	XG2A-340□
40	XY3A-4001	XY3A-4002	XY3A-4003	49.5	50.8	XG4M-4030	XG4E-403□	XG2A-400□
50	XY3A-5001	XY3A-5002	XY3A-5003	62.2	63.5	XG4M-50□□	XG4E-50□□	XG2A-500□
60	XY3A-6001	XY3A-6002	XY3A-6003	74.9	76.2	XG4M-60□□	XG4E-60□□	XG2A-600□
64	XY3A-6401	XY3A-6402	XY3A-6403	80.0	81.3	XG4M-64□□	XG4E-64□□	XG2A-640□

**Note:** Dimensions A and B are for the contact area of folding flat cable.

## ■ Ratings and Characteristics

Classification	XY3A-□□01 Standard Cables	XY3A-□□02 Folding Cables	XY3A-□□03 Color-coded Cables
UL file No.	UL2651	UL20012	U:20028
Max. operating voltage	300 V	150 V	150 V
Max. operating temperature	105°C	80°C	105°C
Max. conductor resistance	224 Ω/km (at 20°C)		
Dielectric strength	2,000 VAC, 50/60 Hz for 1 min		
Min. insulation resistance	5 kΩ·km (at 20°C)		

## ■ Materials

Conductor	AWG28 (7/0,127), tin plated, soft copper wire
Insulation	Heat-resistant vinyl

## Special Tools

XY2B-0002

IDC Tool (Attachments sold separately)

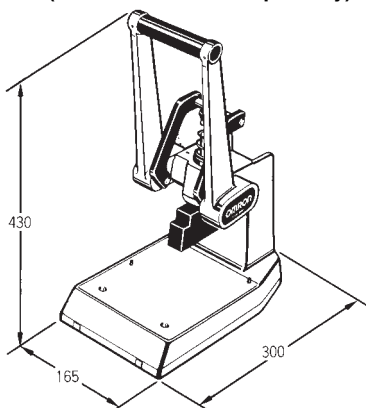

Model
XY2B-0002

## IDC Tool Attachments for XG4M and XG2A

XY2B-1007

Attachment for the XG4M

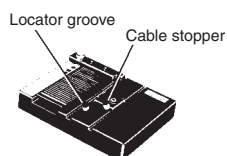

XY2B-1006

Attachment for the XG2A

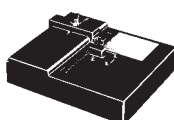

### Operation

XG4M-series Connectors must be placed face down into the locator slot of the Attachment. (With the XG2A Series, place the terminal block in the Attachment.) Insert the cable until it is flush against the cable stopper. Connections are made by pulling the handle towards you until it stops. For details on operation, see the user's manual supplied with the IDC Tool.

### Combinations

IDC Tool	Attachment	Applicable Socket
XY2B-0002	XY2B-1007	XG4M (All contacts)
	XY2B-1006	XG2A (All contacts)

## IDC Tool Attachments for XG4E

XY2B-1004

Attachment for the XG4E



XY2B-14□□

Spacer for the XG4E

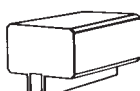

### Operation

XG4E-series Connectors must be placed face down into the locator slot of the Attachment. Insert the cable until it is flush against the cable stopper. Next set the proper spacer for the Plug. Connections are made by pulling the handle towards you until it stops.

### Ordering Information

IDC Tool	Attachment	Spacer	Applicable Plug
XY2B-0002	XY2B-1004	XY2B-1401	XG4E-10□1/-10□2 XG4E-1431/-1432
		XY2B-1402	XG4E-1631/-1632 XG4E-2031/-2032
		XY2B-1403	XG4E-2631/-2632 XG4E-3031/-3032
		XY2B-1404	XG4E-3431/-3432
		XY2B-1405	XG4E-4031/-4032
		XY2B-1406	XG4E-50□1/-50□2
		XY2B-1407	XG4E-60□1/-60□2 XG4E-54□1/-64□2

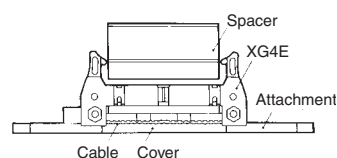

- Application examples provided in this document are for reference only. In actual applications, confirm equipment functions and safety before using the product.
- Consult your OMRON representative before using the product under conditions which are not described in the manual or applying the product to nuclear control systems, railroad systems, aviation systems, vehicles, combustion systems, medical equipment, amusement machines, safety equipment, and other systems or equipment that may have a serious influence on lives and property if used improperly. Make sure that the ratings and performance characteristics of the product provide a margin of safety for the system or equipment, and be sure to provide the system or equipment with double safety mechanisms.

**Note: Do not use this document to operate the Unit.**